



**maglink™**

**Instruction manual**



**SIMAGIC**  
KEEP  
RACING

Before purchasing and using the product, please read this manual.

The data on the page is theoretical and is derived from SIMAGIC's test environment. Actual usage may vary slightly due to product usage conditions and environmental factors. Please refer to the actual usage situation.

We will provide product information, specifications, and features as accurately as possible. At the same time, we may adjust and correct the textual descriptions, image effects, etc., on the following pages in real time to match the actual product performance, specifications, indices, components, etc. Due to real-time changes in production batches and production supply factors, if there is a need for the aforementioned modifications and adjustments, we regret that we may not provide specific notifications. Please refer to the latest information released through official channels such as [www.simagic.com](http://www.simagic.com) for the most up-to-date information.



Video installation and  
usage tutorial

# Contents

<b>1. Company Intro</b> .....	P1	<b>4. Software</b> .....	P15
<b>2. Product Introduction</b>		<b>5. Notes</b>	
2.1 Product Models .....	P2	5.1 Instruction for Use .....	P16
2.2 Product Intro .....	P3	5.2 Warranty Instructions .....	P17
2.3 Product Data .....	P4	5.3 Safety Instructions .....	P18
2.4 Product Highlights .....	P6		
2.5 Packing List .....	P12	<b>6. Contact us</b> .....	P19
2.6 Recommendations .....	P13		
<b>3. Quick Guide</b> .....	P14		

Coming from modest backgrounds, but infected by the need for speed.

Although we had some talent in real life racing, the lack of funds to fuel that passion was not enough to satisfy our addiction in comparison to real life motorsports and is still beyond the reach of many. However, we are determined to find ways to improve our skills and make practice effective and affordable.

It started with us asking ourselves, “How do we find ways to satisfy this goal in the most immersive ways?”

In 2018, fueled by this passion and armed with advanced degrees in engineering and control systems, SIMAGIC was born.

We went about developing the kind of wheelbase we wanted and needed. It had to be direct drive for unmatched realism, yet affordable. The goal was to make it easy to use and built with high quality components to last; using real carbon fiber and metal where possible, with high quality components and zero compromises. After all, we were in Shenzhen, the Silicon Valley of the East, factory to the world, the talent and resources were all here.

While we were at it we thought to ourselves, why not make it just like real race cars with a motorsports grade QR system. It’s never been done before so we had to develop new ways of power delivery and data communication to do this. The result is the much loved, and flatteringly imitated, QR system and 2.4G wireless communications system that have become so familiar in sim racing today.

August 2018, the M10 was introduced to the world and it catapulted SIMAGIC into the consciousness of sim racers all over. It has been 3 years since and what followed after were the GT Wheel Series, FX Wheel Series, Alpha Servo Base Series, Pedals, Sequential Shifters, Handbrakes and more, the SIMAGIC eco-system is only just the beginning.

3 years is neither short nor long. Short for the amount of innovation and products that we have developed, but long enough to have proven that we are here for the long haul and our products have stood the test of time and our commitment to all who have believed in us.

One thing remains unchanged, we started with motorsports as a passion and we will continue to drive this point in every product we develop and every innovation we come up with. Everything we do is benchmarked and tested by real drivers who believe in the art of sim as a tool for real life driving. We will continue to commit ourselves to being the choice of real drivers and those who strive to be one. This will always be the one thing that sets us apart from everyone else. The game just got seriously fun, so

KEEP RACING!

**KEEP  
RACING**





**KEEP  
RACING**

- **Unrivalled compatibility: compatible with most 50mm & 70mm QRs on the market with modular QR adaptor**
- **Magnetic connection, easy plug and play experience: robust 32N magnetic force ensures secure attachment**
- **100cm extension cable, allowing the connector to attach to different brackets easily, enhancing Maglink's flexibility**
- **Open ecosystem, SimPro Manager provide complete software support for Maglink connections**
- **Consistent & stable connection, supports direct PC connection, better stability than Type-C connection**



**KEEP  
RACING**

Magnetic connection cable

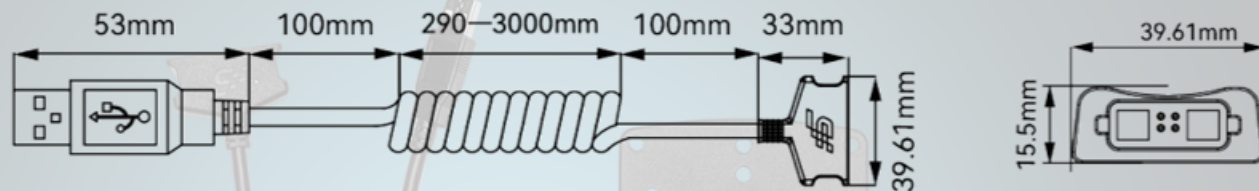

Quick Release Adapter Plate

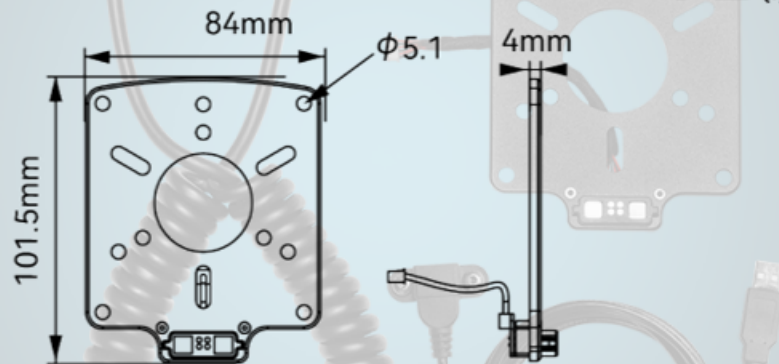

Powerstrip

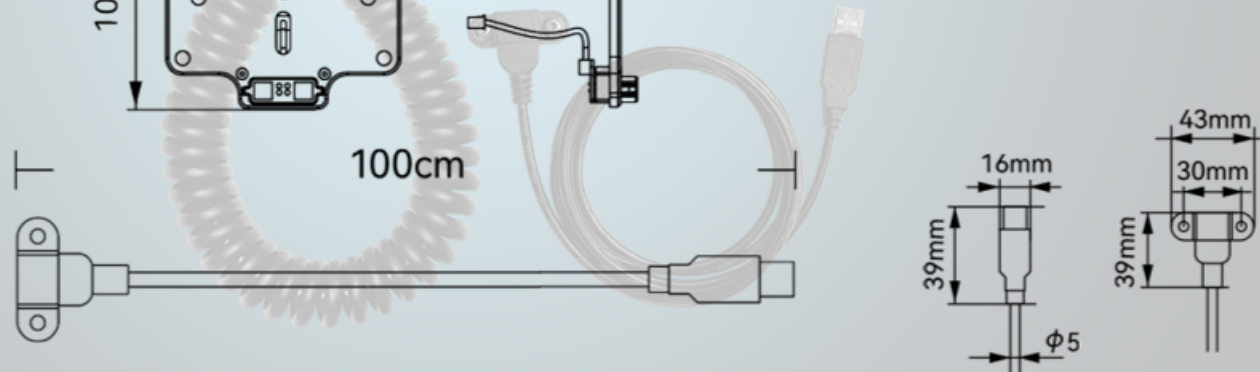

Product name	Compatible wheels	Standard equipment	Compatible QRs	Connection type
Maglink	GT Neo and all Maglink compatible SIMAGIC wheels	SIMAGIC 50QR	Most mainstream 50mm & 70mm OR (e.g. Fanatec, Simucube Moza, Asetek)	PC



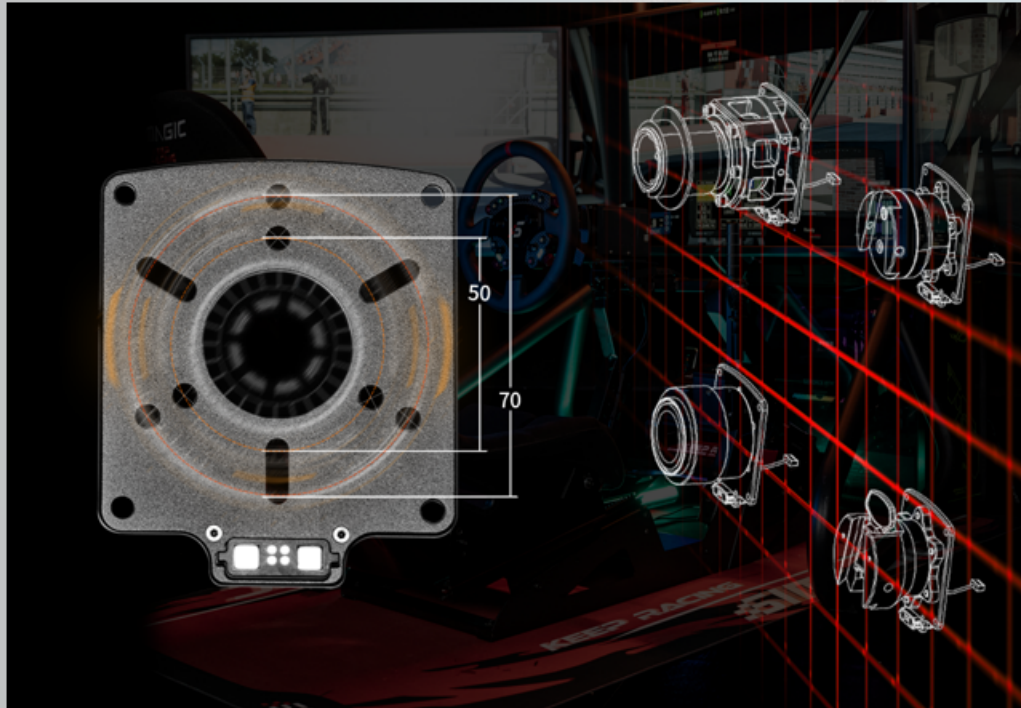

## Unrivaled Compatibility

Compatibility now available on all SIMAGIC wheels that support Maglink

Fits perfectly on most 50mm & 70mm QR's on the market

Facilitating seamless connectivity between the GT Neo and future UP+ steering wheels with mainstream brands



## Revolutionary patent magnetic Connection design

Boasting a robust 32N magnetic force ensuring secure attachment.

Just “Plug”, then you can play!

**KEEP  
RACING**

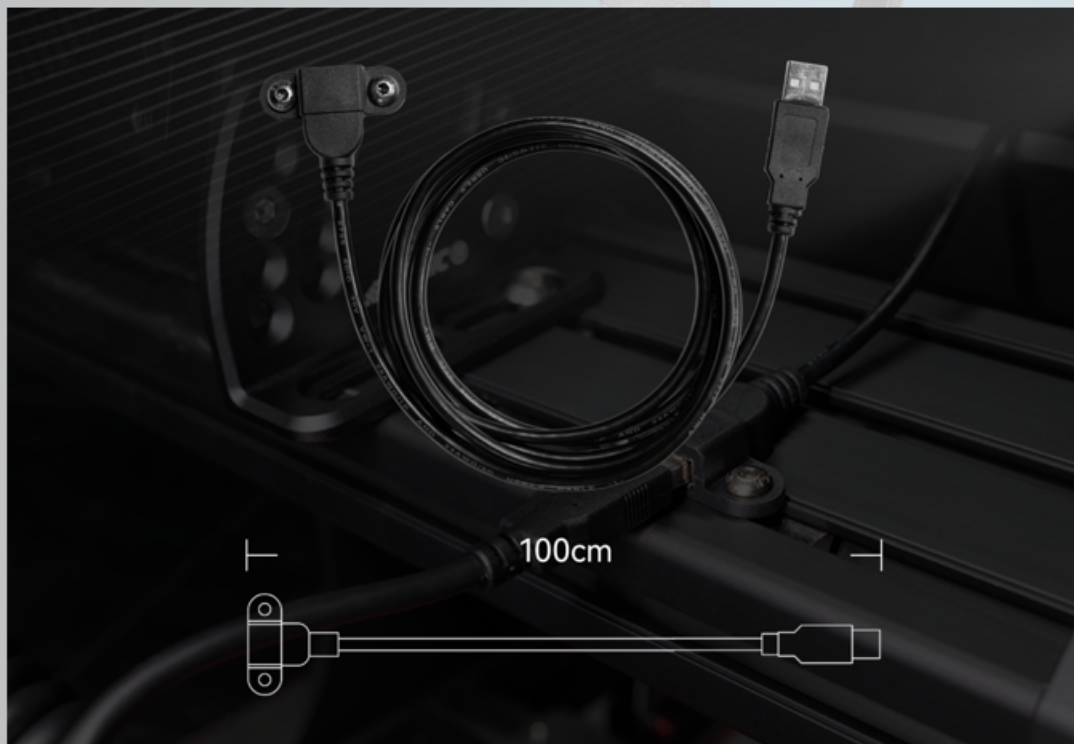

## Enhance Maglink's Flexibility

Attach to different brackets easily

Get the interface closer

Upgrade for better adaptability

**KEEP  
RACING**



## Open Ecosystem

**SimPro Manager:**

**Complete software support for Maglink connections**





**You've got more on the wheel?  
No problem!**

**Better data transfer capability**

**Supports modular wheel display telemetry**

**KEEP  
RACING**

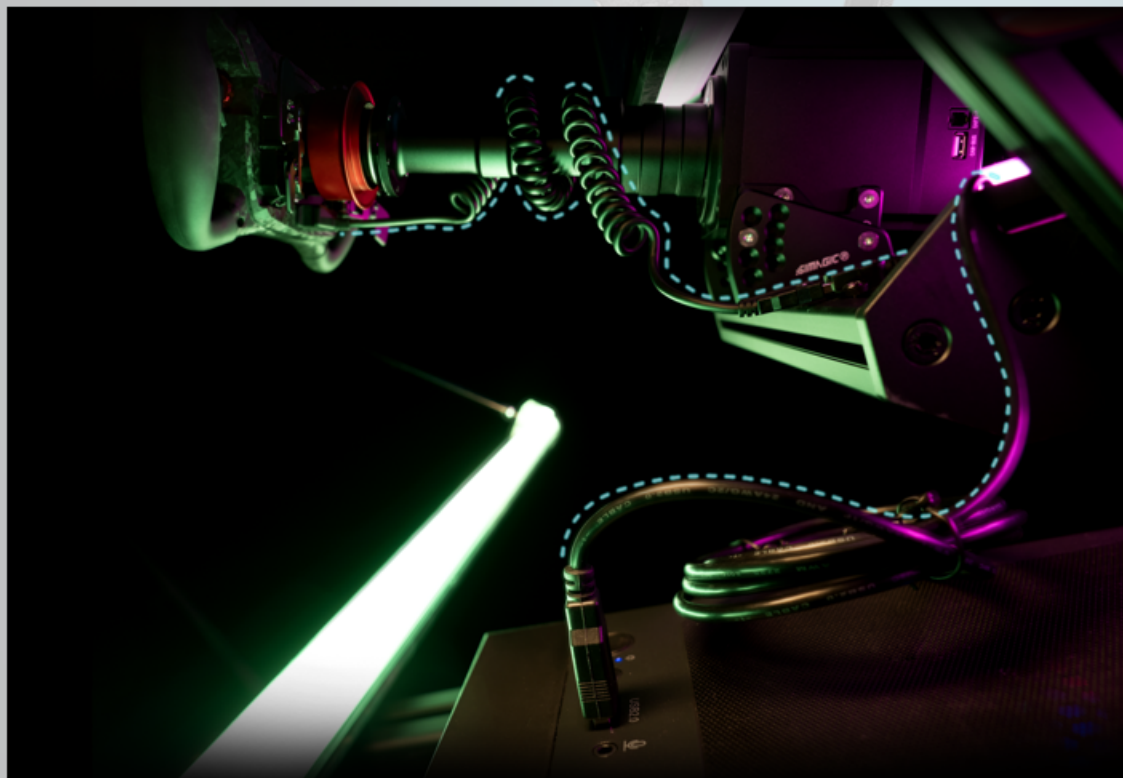

## Consistency & stability are key in racing

Better stability than Type-C connections

Ensures a stable and strong connection while racing

**KEEP  
RACING**



Mounting Screw Pack

Allen key



**GT NEO**

**KEEP  
RACING**



## 1.0 Accessories list

- Countersunk Head Screw M5-12\*6
- Pan Head Screw M5-10\*2
- Roll in T-Nut with Ball Spring M5-40\*2
- Allen key\*1(3mm)

## 2.0 Connecting the steering wheel

### 2.1 Remove the quick disconnect and adapter plate

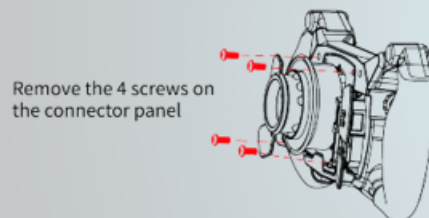

Remove the 4 screws on the connector panel

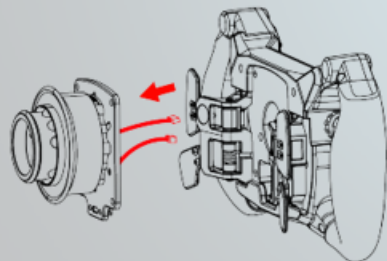

Remove the QR, the panel and the socket  
(Note: Both cables need to be unplugged gently )

### 2.2 Maglink Installation

Secure the desired quick release to the Maglink connector panel with the included Truss head screws

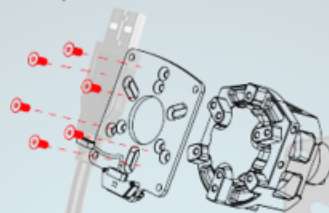

Install the Maglink panel on the wheel and secure with the screws removed from step 1  
(Note: Maglink connector cable has to be plugged in before installation)

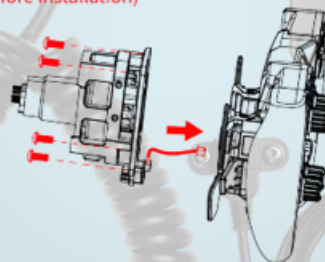

Install the coiled cable by connecting the magnetic socket to the wheel and the USB socket to the PC or USB extension cable



### 2.3 USB extension cable installation

Insert the T-nuts into the section bar, then place the USB extension cable head on top of the slot, and secure it with screws

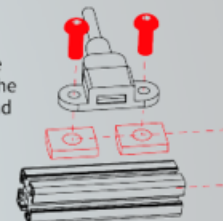

Connect the Maglink USB socket to the extension cable socket

Note: A complete SimPro Manager installation and setup on PC is required for the full functionality of Maglink



**KEEP  
RACING**

This product is ready to use out of the box, and it comes with the latest firmware. For information about firmware upgrades, please check <https://simagic.com/download> or visit the official public account "SIMAGIC Technology."

The related files are game adaptation files developed by SIMAGIC for SIMAGIC-compatible devices. To safeguard users' legal rights and interests, please download all files through SIMAGIC's designated channels.

Please visit [www.simagic.com/telemetry-support](http://www.simagic.com/telemetry-support) to access the list of games supported by this product. Note that using this product in non-supported games may result in certain functions not working as intended.

Information on the product packaging or included in the box, as well as the data on the page, are theoretical values obtained by SIMAGIC in a testing environment. Actual usage may vary slightly due to product usage conditions and environmental factors. Please refer to the actual usage situation.

We strive to provide as accurate product information, specifications, and features as possible. SIMAGIC may adjust and correct the textual descriptions, image effects, etc., on the page in real time to match the actual product performance, specifications, indices, components, etc. Due to real-time changes in production batches and production supply, if there is a need for the aforementioned modifications and adjustments, we regret that specific notifications may not be provided. Please refer to the latest information released through official channels for accuracy.

The product images and content on the above pages are for illustrative purposes only. The actual product effects (including but not limited to appearance, color, size) and display content (including but not limited to background, UI, illustrations) may vary slightly. Please refer to the actual product.

This instruction content serves as a general description for a single product (including different styles under a single product). The product descriptions demonstrated in this content are not sales specifications. The specific product style is based on what the user purchases.

**This product is only intended for simulated driving-related activities. Please differentiate between simulation games and reality and practice safe driving.**

SIMAGIC establishes dealer terms and consumer product warranty terms, requiring official partners such as dealers and agents to provide consumers with standardized SIMAGIC warranty services to safeguard consumers' legal rights. For information on authorized dealers, please visit [simagic.com/experience](http://simagic.com/experience).

SIMAGIC adheres to a service spirit that is responsible for users and ensures user confidence, striving to create the ultimate user experience. Regarding these warranty terms, if adjustments are necessary, we regret that specific notifications may not be provided. Please refer to the latest content released through official channels such as the official website.

Please avoid causing damage to the machine intentionally. Do not deviate from the guidance of official or officially authorized personnel when performing non-normal hardware or system operations on the machine. For detailed usage instructions, please visit [www.simagic.com/pro-tutorial](http://www.simagic.com/pro-tutorial) or check the official public account "SIMAGIC Technology" and other SIMAGIC official information channels.

#### 【Warranty Terms】

The product warranty card included inside the product packaging box should be carefully preserved by the user as proof for repairs.

The warranty period is twelve months from the date of purchase.

During the warranty period, if there are issues with the machine's components, materials, or craftsmanship under normal use and maintenance, and the problem is confirmed after inspection, the company will provide free repairs and replacement parts.

#### 【Disclaimer】

Damage to the machine caused by incorrect installation or operation.

Repairs, modifications, alterations, or self-replacement of any internal components by non-technical personnel of the company.

Alteration of the machine serial number or inconsistencies with this certificate.

Damage caused by negligence, water, or infiltration of other substances into the machine. Malfunctions or damage caused by accidents or natural disasters.

Users are prohibited from personally opening the machine's casing, as doing so may void the warranty and other guarantees.



- \* The equipment and power supply must not be exposed to a humid environment to prevent short circuits or electric leakage, which may lead to equipment damage/malfunction and fire incidents.
- \* It is prohibited to expose the equipment to heat sources.
- \* The equipment must be connected using the factory-supplied power and power cables. Even if the voltage matches, the use of non-original matching power and power cables is prohibited to ensure electrical safety.
- \* Only use AC power provided by a standard wall outlet to avoid damage to the product.
- \* When terminating use, please turn off the buttons and power equipment to prevent accidents.
- \* photosensitive epilepsy: if you have a history of epilepsy or seizures, consult a doctor before use. certain patterns may trigger seizures with no prior history. If you experience any symptoms, please stop using the product immediately and consult a doctor
- \* In case of prolonged inactivity, unplug the power cord to disconnect the device from the power source.
- \* To ensure safety, component replacements must be carried out or authorized by SIMAGIC's official repair center.
- \* The device contains components that users cannot repair. Users are prohibited from opening the device's casing to avoid injury from the motor.
- \* Children under 6 years old are prohibited from using this device.
- \* The device has significant force feedback and contains small components. Children under 13 years old are prohibited from operating or using it independently. When in use, parents must adjust the force feedback parameters in child mode and supervise.
- \* For first-time users, adjust the force feedback gradually to an appropriate level.
- \* First-time users or those experiencing the device should be guided by the device owner.
- \* Loose clothing items such as hair, cables, skirts, etc., should be kept away from the simulator.
- \* When using a high-torque base, the peak force feedback may cause hand injuries. If the feedback is too strong, release your hands immediately and adjust the feedback intensity parameters promptly to prevent potential accidents.
- \* It is recommended to limit force feedback gaming time to 1 hour to avoid health risks from excessive use. Take a break for 5 minutes every 20 minutes, and the daily driving limit per person is 2 hours. Users should refrain from driving a real car for at least 1 hour after finishing the game.
- \* If any abnormalities are detected, stop using the device immediately and seek assistance from SIMAGIC's official or authorized service center.
- \* Please follow SIMAGIC's official website and public platforms for the latest product information.



Facebook



Instagram



X



WeChat

JOIN OUR SOCIAL MEDIA NETWORK  
AND SHARE YOUR PASSION

**KEEP  
RACING**